

PX-619S

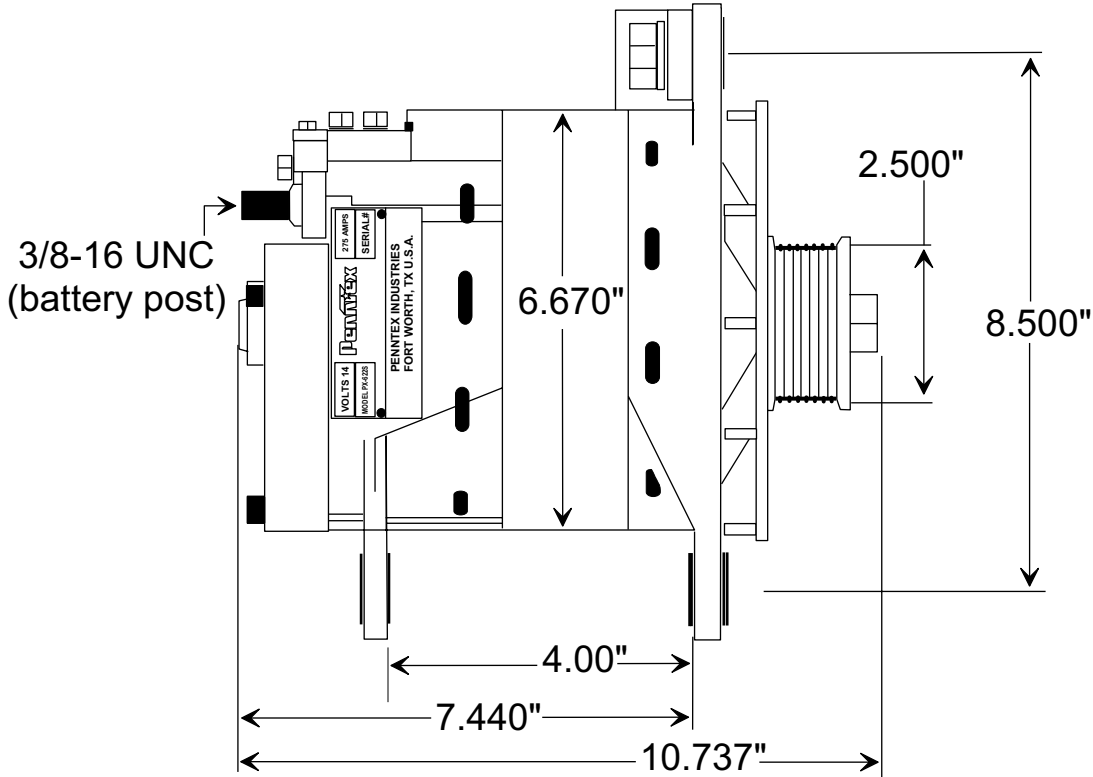

NOTE:

ALL DIMENSIONS ARE LISTED FOR QUICK REFERENCE. CONTACT PENNTEx FOR PRECISE MEASUREMENTS IF REQUIRED FOR BRACKETS OR SPECIAL APPLICATIONS.

PenntEx
INDUSTRIES, INC.
DRAWING BY DMc.

DATE: 01-14-2008
Scale: None

**PX-6S-190 ALTERNATOR
FROM PX-619S KIT, 24 VOLT,
190 AMP, J-180 MOUNT**